



CUSTOM LEATHER PROGRAM



Customize and create your own unique leather seating with over 30 pieces and a wide variety of leathers!

Sofas, Loveseats, Chairs, Ottomans

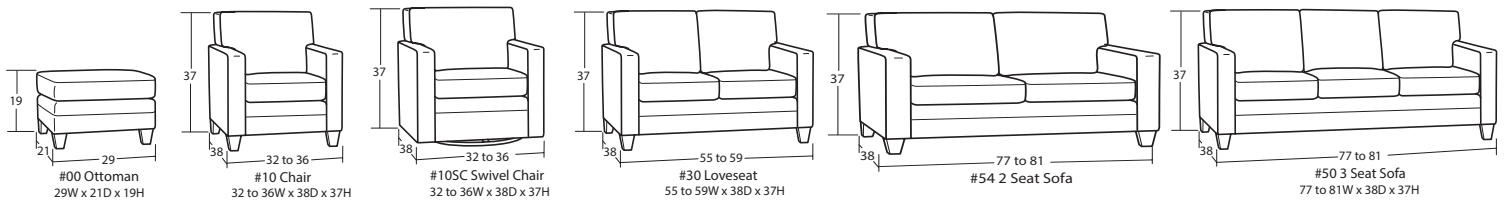

Sectional Pieces

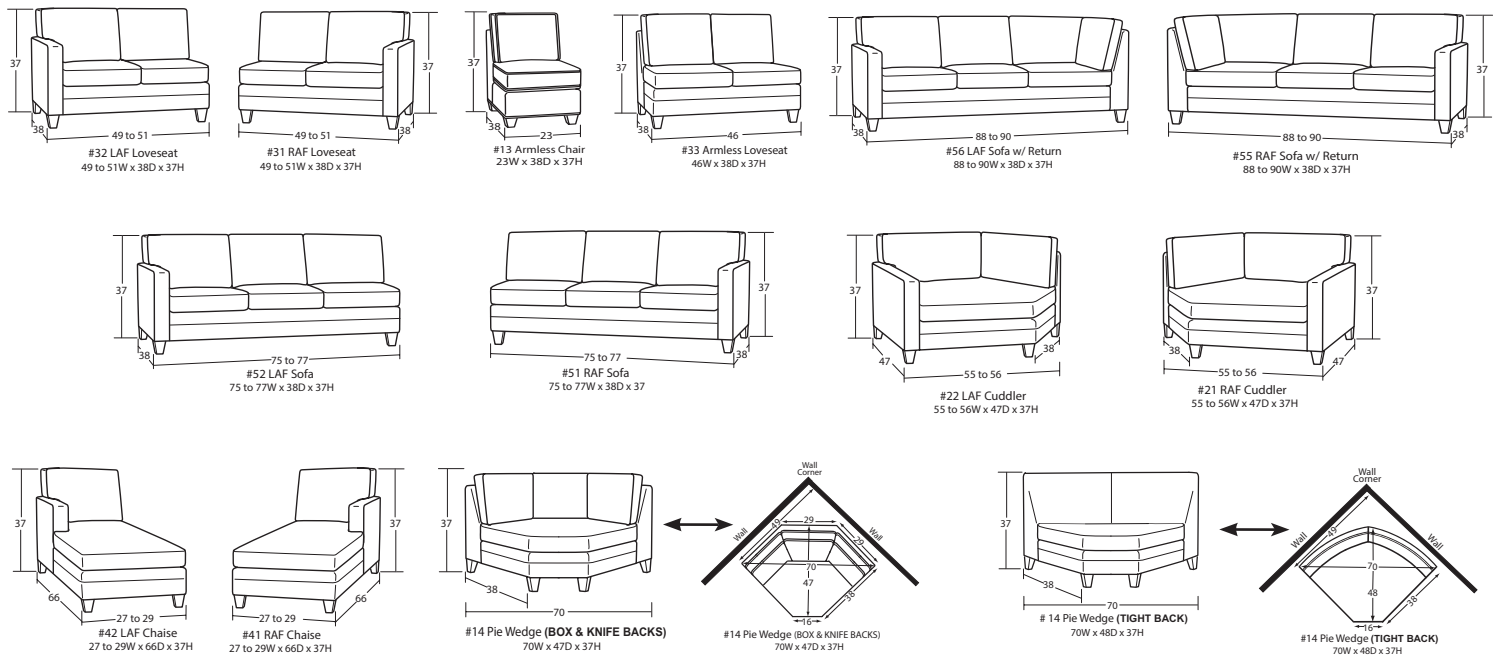

Sleepers

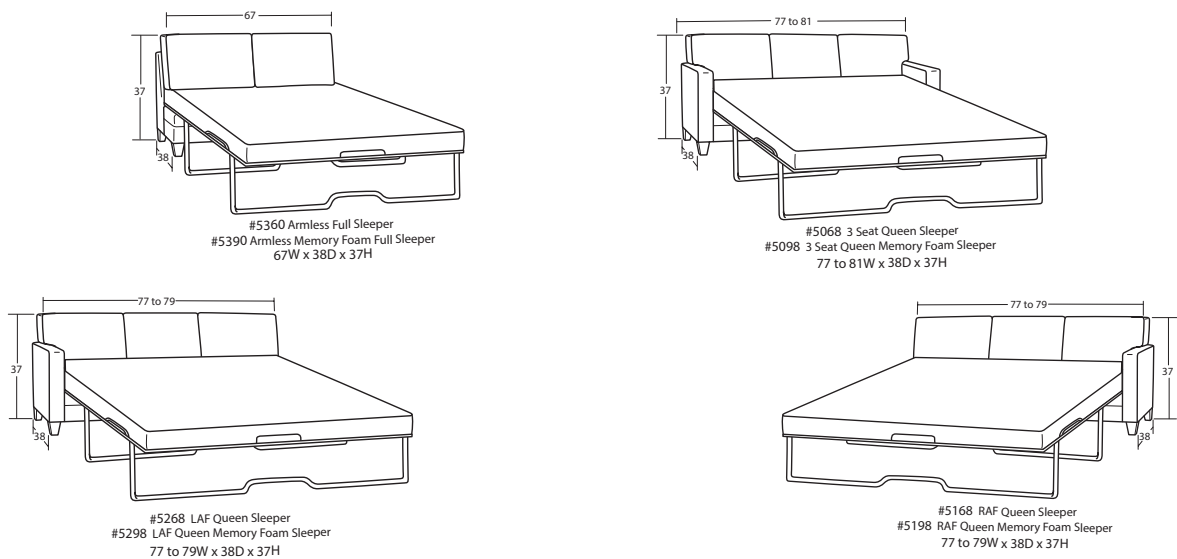

Cocktail Ottomans

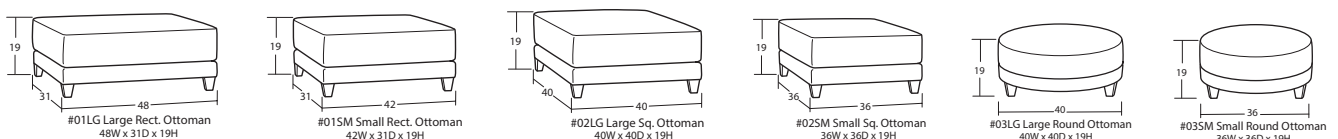

* **Comfort Coil Cushion (DPT)** - 2.0 High density high resilient foam core with 50-60 pocketed micro-coils all encased in 100% cotton down proof ticking. Available in L9, LC9 and LM9.

* Width varies depending on arm style selected.

* See price list for specific dimensions.

* Arm height for all pieces is 28".

The Art of Leather, Made Personal.
Sample Configurations

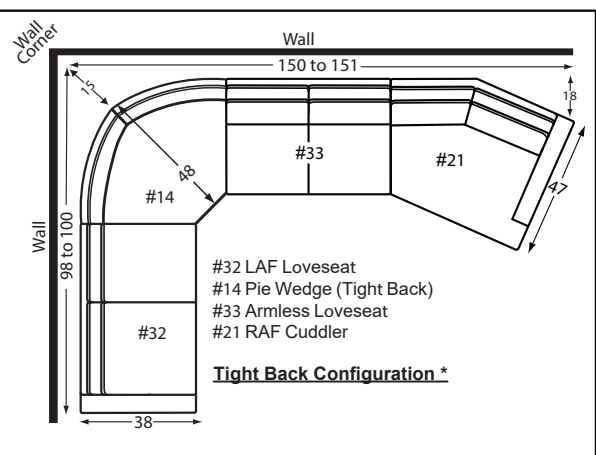
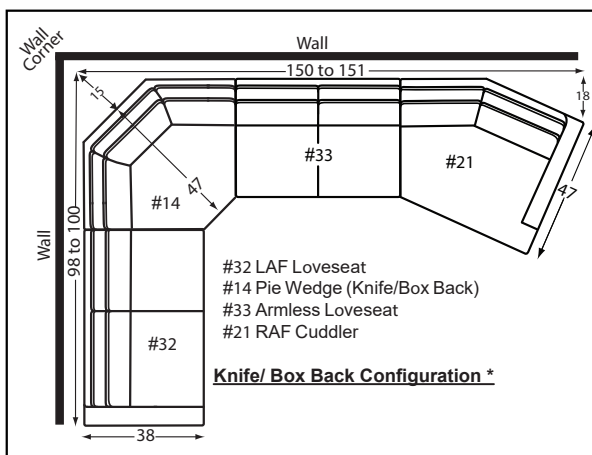
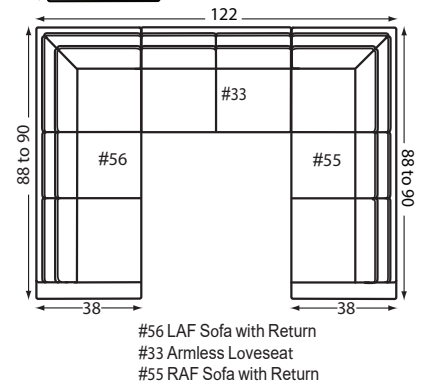
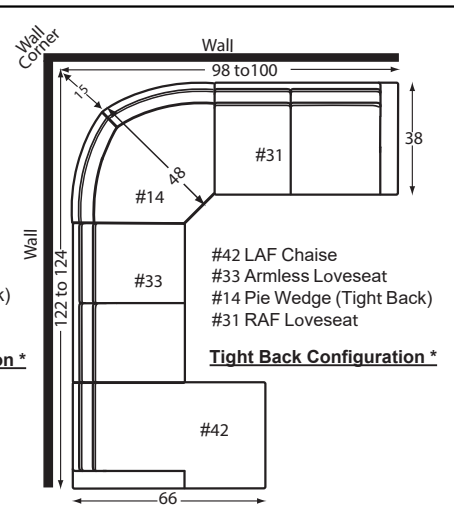
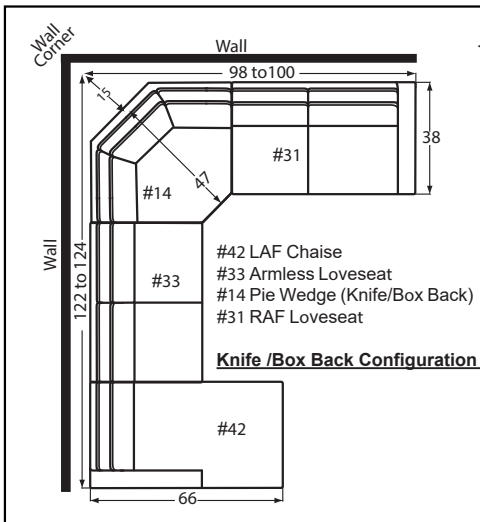
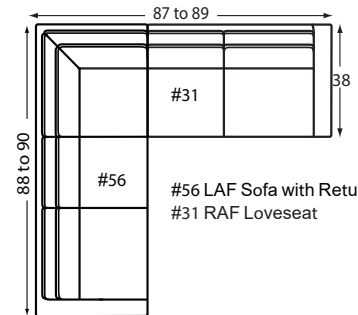
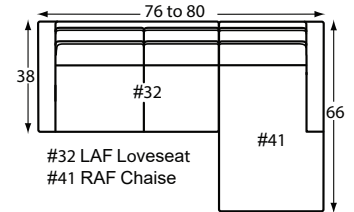
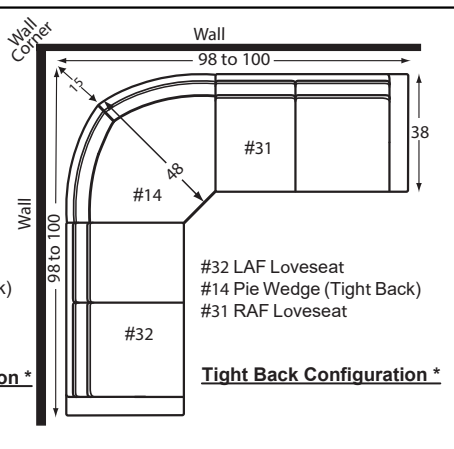
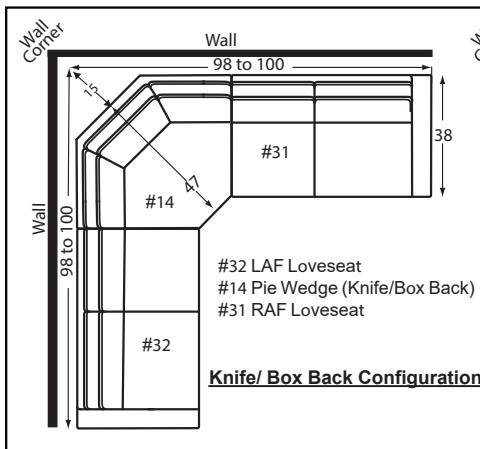
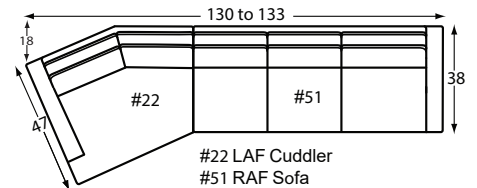
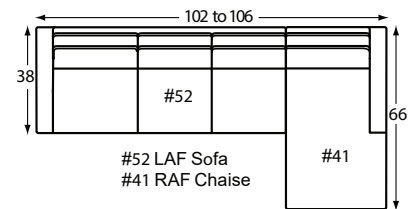
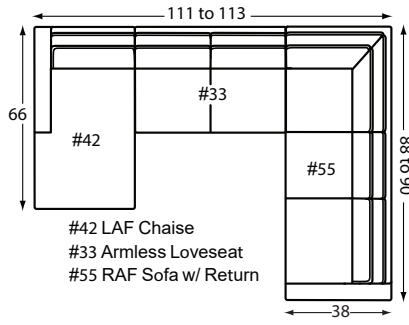
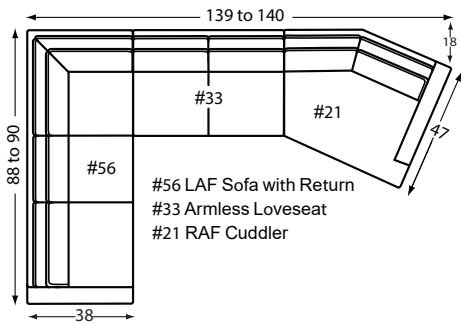
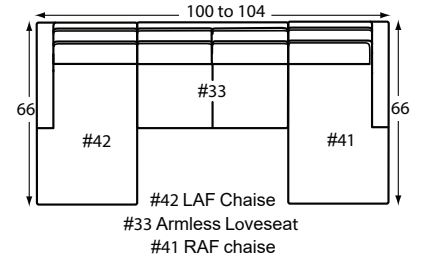
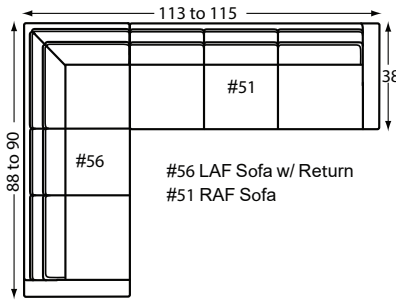
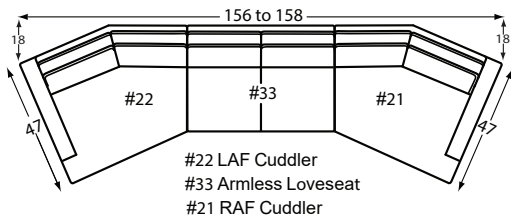

* Our tight back pie wedge has a different shape and dimensions than the knife or box back pie wedge.